

# CHEM

design Davide Diliberto

CHEM is a radiator comprising round tube elements,  $\varnothing$  9 cm, with the final section curving

towards the wall. It is produced in different heights, either as a single unit or as a modular

unit with up to 7 elements. It can be supplemented with the element at its curvst height 96 cm

## DIMENSIONS

Width: da 9 a 93cm  
 Height: 96 /196 /216 /236 /256 cm  
 Depth: 18 cm  
 Depth from wall: 18 cm

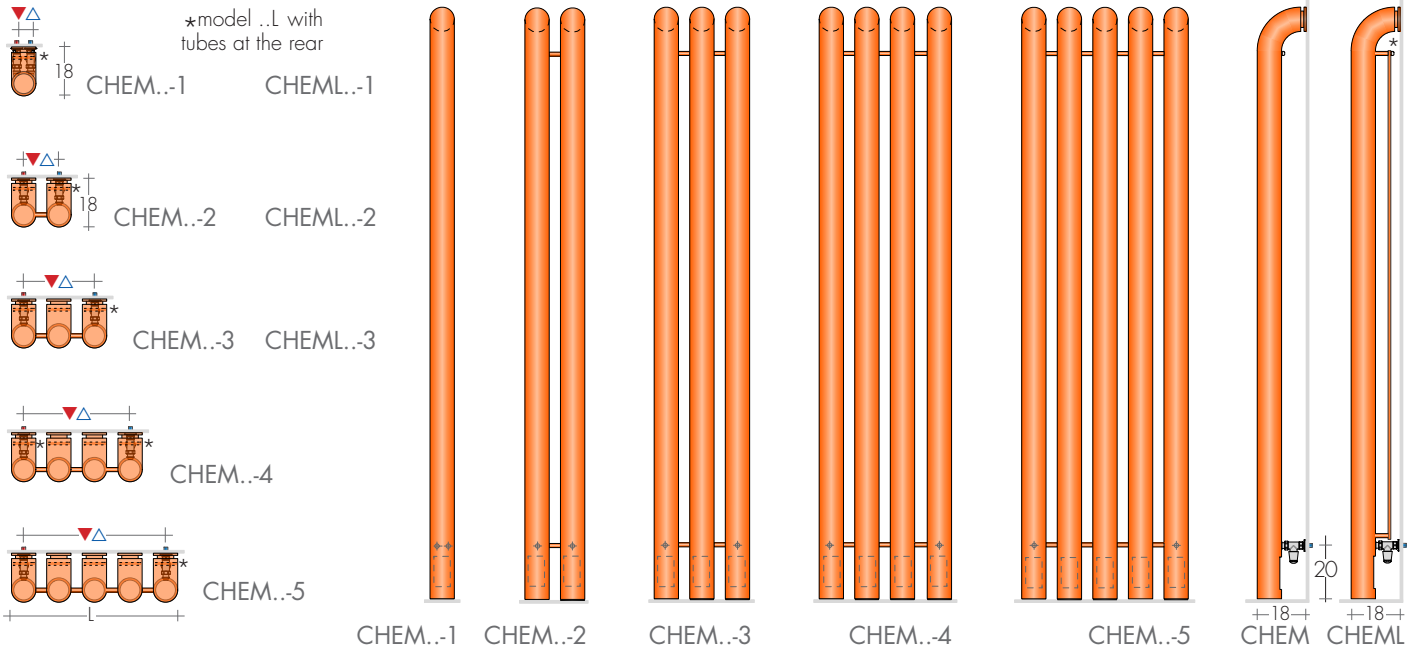

MODEL	H cm	n°el. L cm ▲▼ cm	1el	2 el	3 el	4 el	5 el	6 el	7 el
			9 5	23 14	37 28	51 42	65 56	79 70	93 84
CHEM 196 €			649,60 326w	873,60 655w	1097,60 984w	1338,40 1313w	1579,20 1642w		
CHEML 196 €			750,40 493w	1075,20 989w	1400,00 1485w	1741,60 1981w	2083,20 2477w		
CHEM 216 €			683,20 367w	924,00 737w	1164,80 1107w	1422,40 1477w	1680,00 1847w		
CHEML 216 €			788,50 555w	1134,60 1113w	1480,60 1671w	1843,50 2229w	2206,40 2787w		
CHEM 236 €			716,80 408w	974,40 819w	1232,00 1230w	1506,40 1641w	1780,80 2052w		
CHEML 236 €			826,60 617w	1193,90 1237w	1561,30 1857w	1945,40 2477w	2329,60 3097w		
CHEM 256 €			750,40 449w	1024,80 901w	1299,20 1353w	1590,40 1805w	1881,60 2257w		
CHEML 256 €			864,60 679w	1253,30 1361w	1641,90 2043w	2047,40 2725w	2452,80 3407w		
CHEM 96 €			313,60 138w	431,20 279w	548,80 420w	666,40 561w	784,00 702w	901,60 843w	1019,20 984w
CHEML 96 €			395,40 217w	594,70 437w	794,10 657w	993,40 877w	1192,80 1097w	1392,20 1317w	1591,50 1537w

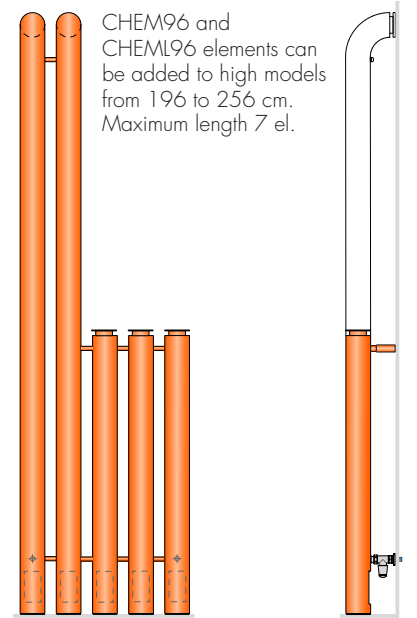

Ex: CHEM216-2el+ 96-3el  
 924,00€+598,080€=1522,80€

On request elements with heights 206, 226. Prices and yields by interpolation.  
 Heights up to 286 cm: to quote. Heights less than 96 cm on request.

^Maximum operating pressure CHEML 4 BAR

## STANDARD PRODUCTION

White "sablé" paintwork - Brackets white  
 Tolerance  $\pm$  3mm - Air vent  $\varnothing$  1/8"  
 MAXIMUM OPERATING PRESSURE 8 BAR

## PRODUCTION ON REQUEST

Paintwork to Brem color list (with colored brackets) +15/25%  
 Electric version, not available

STANDARD FITTING EG  $\varnothing$  1/2", on the back of the tube with straight valves. Side connections with angle valves on request.



## TAPPING CENTRES

CHEM ..1el. CHEM.. - from 2 to 4 elements

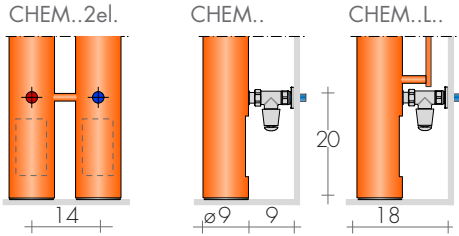
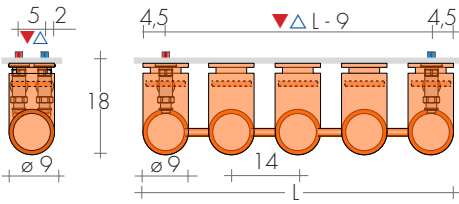

\*model ..L with tubes at the rear

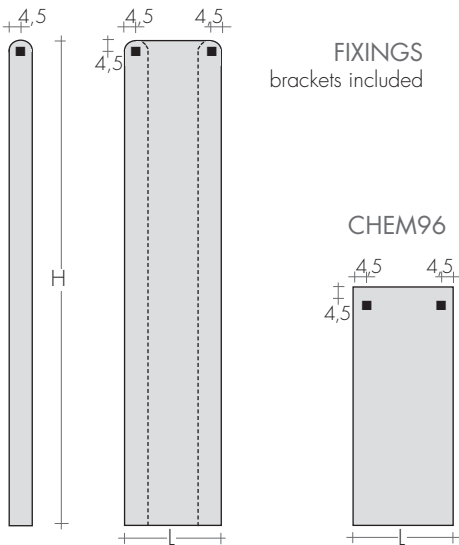

FIXINGS brackets included

CHEM96



CHEM 216-3

## RECOMMENDED VALVES

CHROME PLATED VALVES KIT WITH:

- n°2 Valves with O-ring Tangs
- n°2 Fittings (multilayer ø16, copper ø12,14)
- n°2 Round washers

On request: Polished stainless tube cover (to be cut to right size) Art. CA18 12,40€

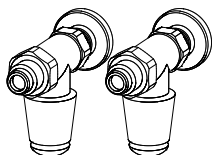

STRAIGHT TON VALVES KIT Art. KVD 149,30€

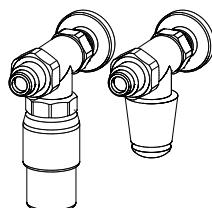

STRAIGHT TON VALVES KIT with THERMOSTATIC head Art. KTD 202,40€

REMOTE VALVES ASSEMBLY KIT with: - n°2 Fittings (multilayer ø16, copper ø12,14)

REMOTE FITTINGS Art. REM 42,10€ at the rear (EG tapping centres dimensions)

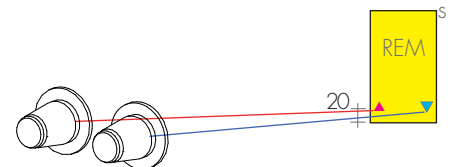

REMOTE QUADRA VALVES ASSEMBLY KIT Art. KQG 192,90€

REMOTE TON VALVES ASSEMBLY KIT with THERMOSTATIC head Art. KVT 229,80€

REMOTE TON VALVES ASSEMBLY KIT with THERMOSTATIC head Art. KVT 229,80€