



FUNKY_S
height 1455 mm, lenght 500 mm. Black finish (cod. 10).

Technical features:

- steel towel warmer radiator
- horizontal elements featuring with a 23 mm diameter
- side round manifolds with a 30 mm diameter
- manifold threading 1/2" Gas right
- maximum working pressure 8 bar
- maximum working temperature 95°C
- 50 mm connection
- not suitable for installation with a single-pipe system

Price included:

- 4 wall fixing in the same color as the radiator
- 2 1/2" hidden air vents complete with valve cover

Finishes available

Standard White
Classic finished
Special finished
Other RAL colors

Surcharge

Finishing codes see page 596.

Connection dimensions with IRSAP valves

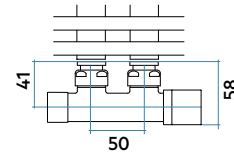

50 mm REVERSIBLE connection

The radiator can be installed with the 50 mm headers on the left or right by simply rotating the product by 180°.

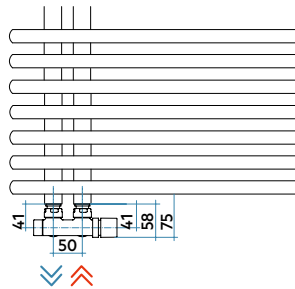

Type with collectors on the left
Hydraulic connection 50 mm

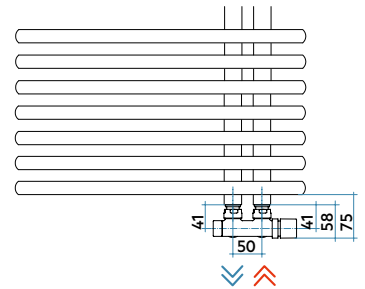

Type with collectors on the right
Hydraulic connection 50 mm

TYPICAL INSTALLATION FOR ALL RADIATORS USING A TEE

"A" quota for IRSAP angle pattern valves and lockshield valves = 40 mm

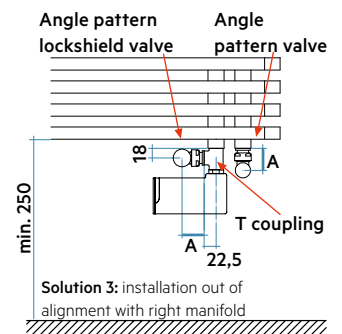
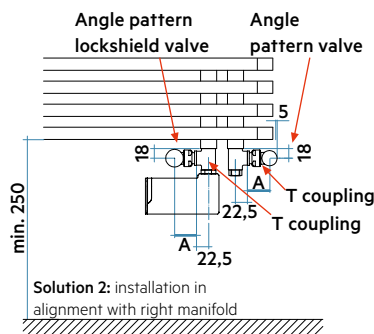
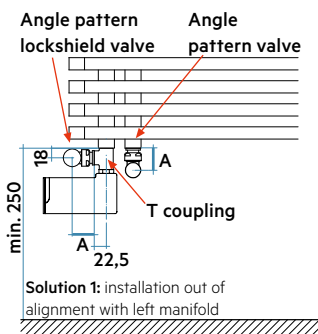

Order code: **VALKROSQMISTS01**

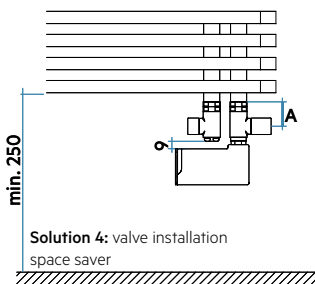

Order code: **VALKROSQMIST01**

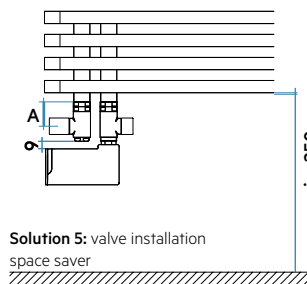

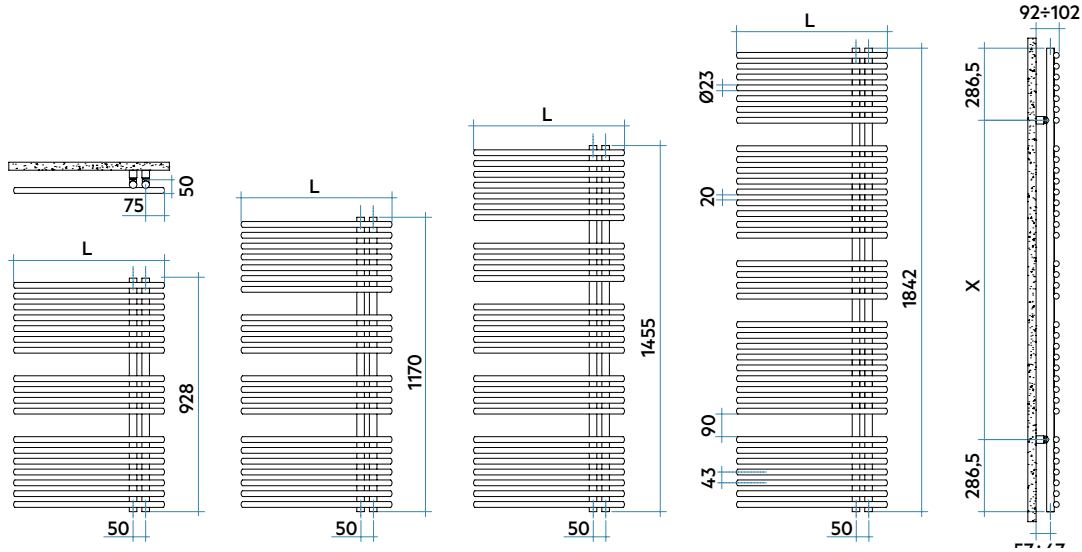

L mm	H mm	X mm
500	928	355
500	1170	597
500	1455	882
600	1842	1269



Model	Code	Depth mm	Height mm	Width mm	Conn. centre mm	Weight Kg	Cap. lt	Thermal Power $\Delta t=50^{\circ}\text{C}$ Btu/h	$\Delta t=50^{\circ}\text{C}$ Watt	$\Delta t=40^{\circ}\text{C}$ Watt	$\Delta t=30^{\circ}\text{C}$ Watt (*)	$\Delta t=20^{\circ}\text{C}$ Watt	Exp. n.
928 18 rails 2 espaces	YRS050 B 01 IR 01 NNN	50	928	500	50	8,7	3,5	1373	402	309	220	136	1,183
1170 22 rails 3 espaces	YRM050 B 01 IR 01 NNN	50	1170	500	50	10,6	4,1	1665	488	374	265	163	1,198
1455 27 rails 4 espaces	YRL050 B 01 IR 01 NNN YRL060 B 01 IR 01 NNN	50	1455	500	50	13,0	5,0	2019	592	447	311	187	1,257
1842 36 rails 4 espaces	YRG060 B 01 IR 01 NNN	50	1842	600	50	19,2	7,6	3039	891	676	473	286	1,238

Mix. Funct.	Code
400	ANRES400WDI
400	ANRES400WDI
700	ANRES700WDI
700	ANRES700WDI
1000	ANRES1000WDI

Electric heater for Dual Power

BATHROOMS
RADIATORS

(*) Thanks to the high performance of Irsap FUNKY_S radiators, the ideal Δt for low temperature projects is Δt at 30°C .

For Δt different from 50°C use the formula: $Q=Q_n (\Delta t / 50)^n$

To order a radiator in the mixed version put the code of the Standard version + the code of the corresponding electric heater

Example: Mod. 1455 x 600: **YRL060 B 01 IR 01 NNN** (€ 409,00) + **ANRES700WDI** (€ 183,57) = Tot. € 592,57

Key Codes

Width	Standard White colour code - for different colour codes see the colors page
YRS050B	01IR01NNN
Height	Packing code
	Standard hydraulic code connection

Decorative & Technical Accessories

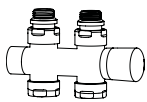

Kit Valves and
Lockshield valve
Pag. 562

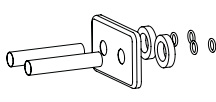

Pipe cover kit
Pag. 566

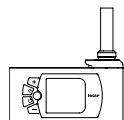

Electronic Control
Pag. 574

