

◀ **Radiator**

Willow V 1900 ↑ x 668 ↔ ZX,
radiator colour: Halo,
radiator code: GWWIV190066 KHALZX

Valves and accessories

Integrated thermostatic valve, angled,
RAL 9005 Mat
VAZ thermostatic head, Brass

251 COLOURS



WILLOW V 

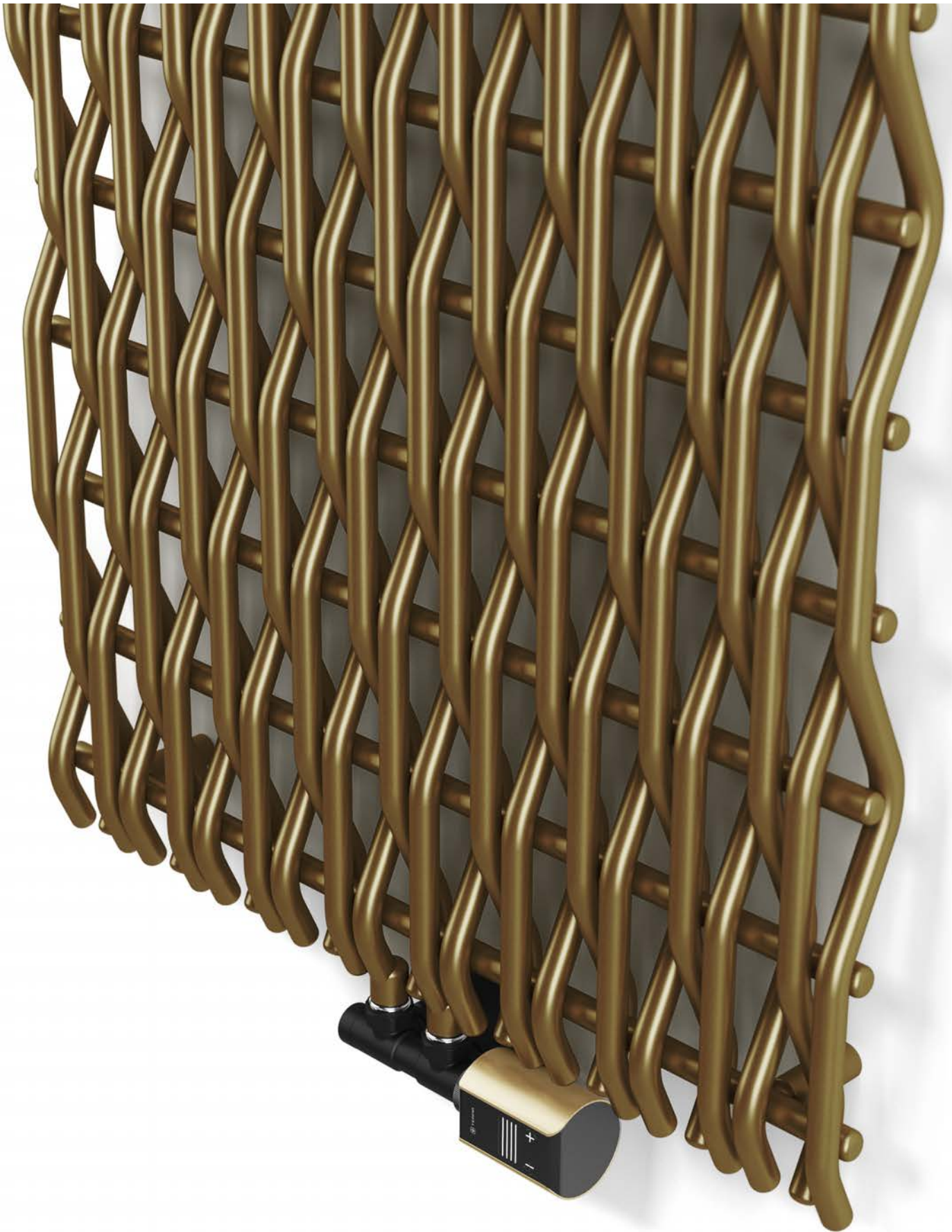

AVAILABLE SIZES

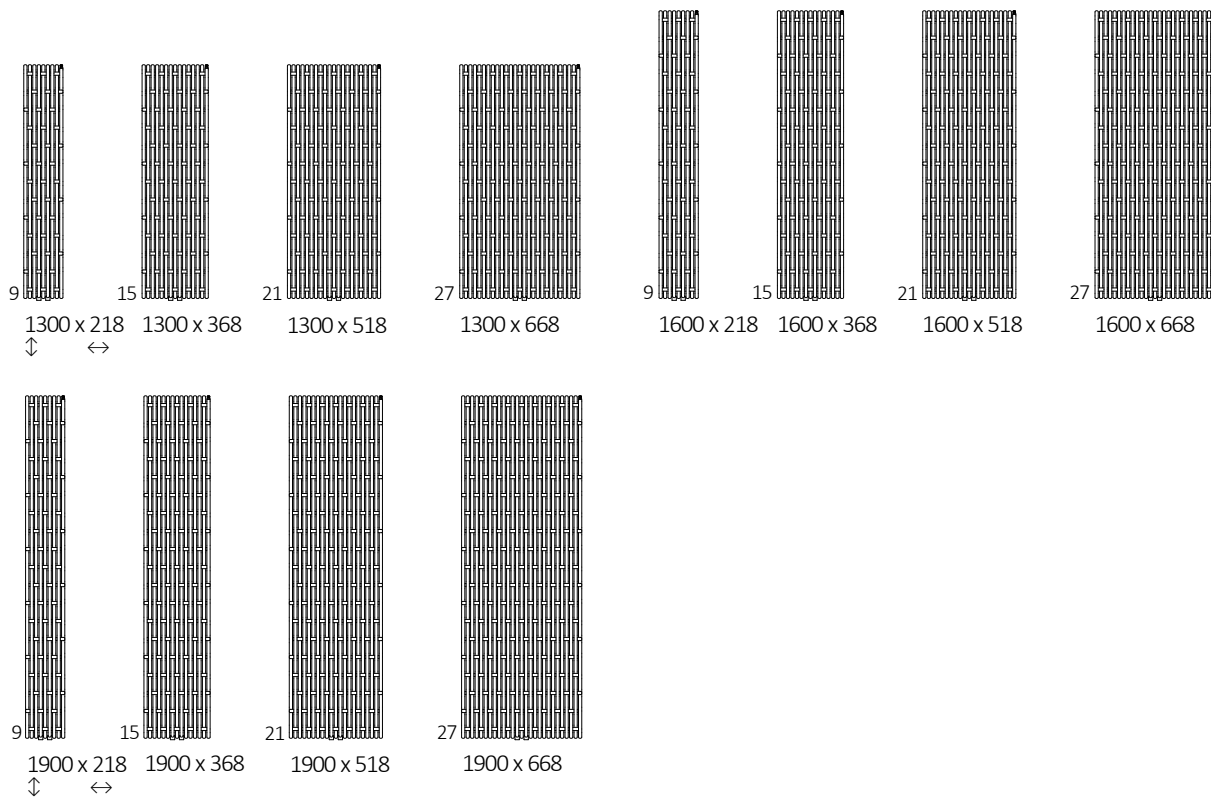

1. RADIATOR

CENTRAL HEATING / DUAL FUEL

Connections:





Height A ↓ [mm]	Width B ↔ [mm]	Heating power – powder paint		Product code ... Configuration p.7
		75/65/20°C [W]	55/45/20°C [W]	
1300	218	408	212	WGWIV130021
1300	368	681	353	WGWIV130036
1300	518	953	494	WGWIV130051
1300	668	1225	635	WGWIV130066
1600	218	503	257	WGWIV160021
1600	368	839	429	WGWIV160036
1600	518	1174	600	WGWIV160051
1600	668	1509	771	WGWIV160066
1900	218	617	315	WGWIV190021
1900	368	1028	525	WGWIV190036
1900	518	1439	735	WGWIV190051
1900	668	1850	945	WGWIV190066

DIMENSIONS AND TECHNICAL INFORMATION

Working pressure: 1000 kPa

Maximum operating temperature: 95°C

Height A ↕ [mm]	Width B ↔ [mm]	Spacing connection C1 [mm]	Spacing connection C2 [mm]	Spacing connection C3 [mm]	Spacing horizontal fasteners D [mm]	Spacing vertical fasteners E [mm]	Bottom fasteners position F [mm]	Capacity  [dm³]	Weight  [kg]
1300	218	50	200	1200	100	1200	50	2,80	8,23
1300	368	50	350	1200	250	1200	50	4,68	13,62
1300	518	50	500	1200	400	1200	50	6,57	19,02
1300	668	50	650	1200	550	1200	50	8,46	24,41
1600	218	50	200	1500	100	1500	50	3,45	10,08
1600	368	50	350	1500	250	1500	50	5,78	16,75
1600	518	50	500	1500	400	1500	50	8,10	23,40
1600	668	50	650	1500	550	1500	50	10,43	30,05
1900	218	50	200	1800	100	1800	50	4,10	11,95
1900	368	50	350	1800	250	1800	50	6,87	19,87
1900	518	50	500	1800	400	1800	50	9,63	27,77
1900	668	50	650	1800	550	1800	50	12,39	35,67

TECHNICAL DRAWING

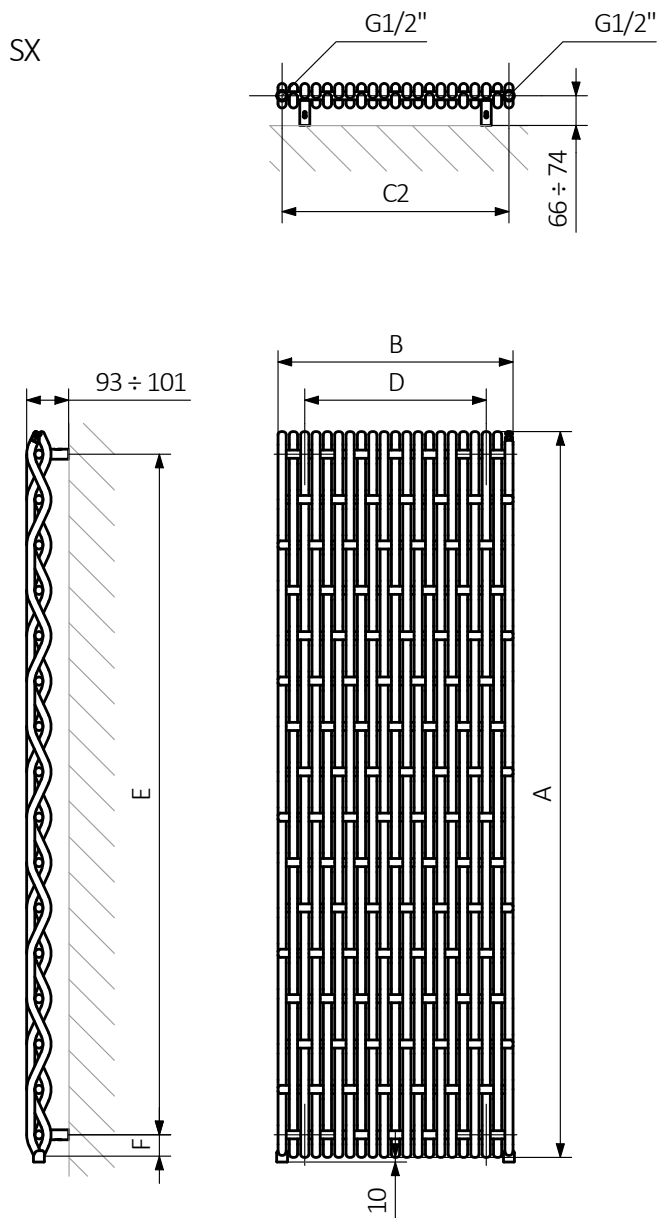

A – Height B – Width C1-C5 – Distance between pipe centres D – Horizontal distance between mounting bracket centres E – Vertical distance between mounting brackets F – Distance between a mounting bracket and the bottom of the radiator

Pipe:

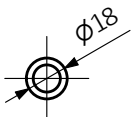

TECHNICAL DRAWING

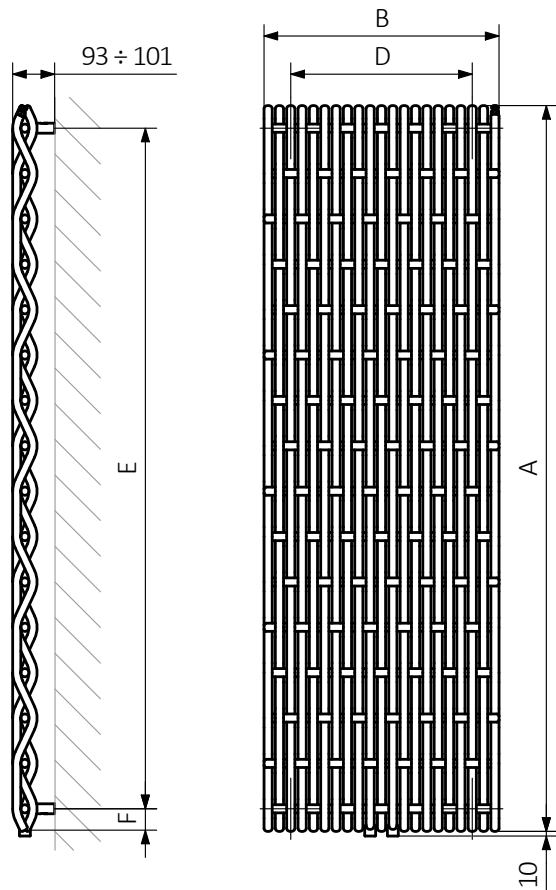
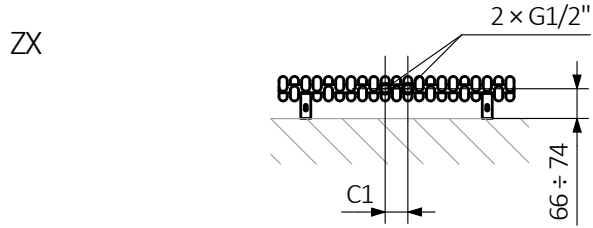

A – Height B – Width C1-C5 – Distance between pipe centres D – Horizontal distance between mounting bracket centres E – Vertical distance between mounting brackets F – Distance between a mounting bracket and the bottom of the radiator

Pipe:

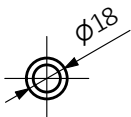

CONFIGURATION CODE FOR A TOWEL RAIL OR RADIATOR ("WG" PRODUCT GROUP)

Product codes can be found in the product tables in both the catalogue and the price list. They provide basic information about the product and the configuration code contains information that complements the specification. When placing an order, the product codes should contain the fully completed configuration part. Part of the configuration code should be placed after the main product code as shown in the example below:

CODE DETAILS:

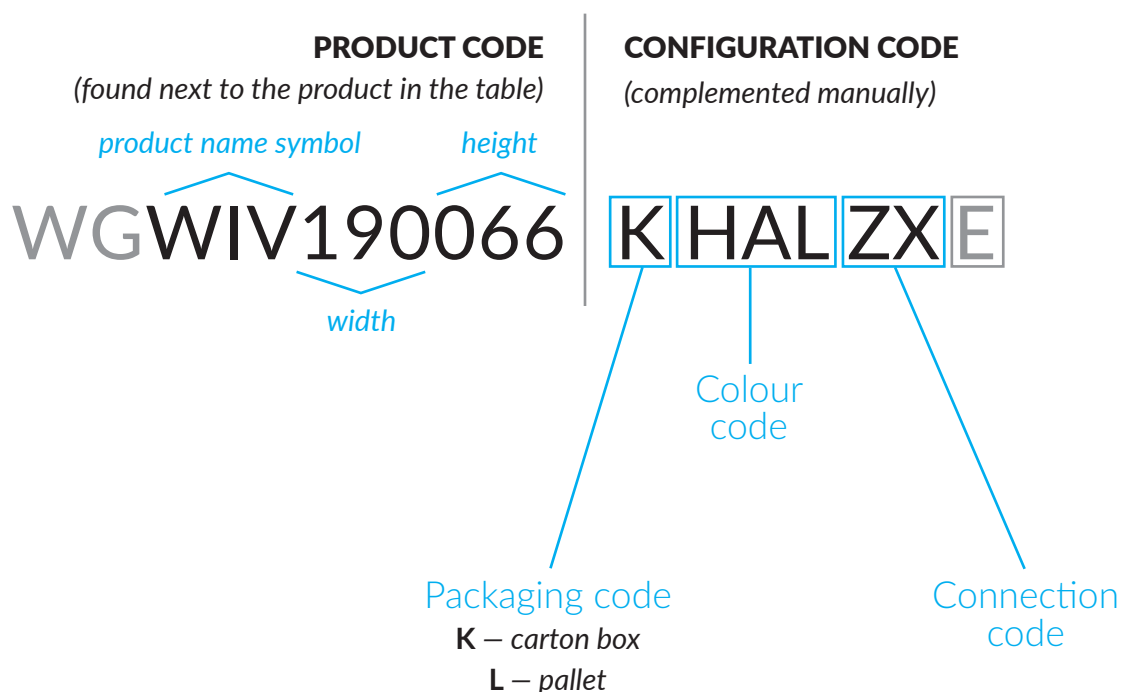

WG – water or dual fuel, central heating towel rail or radiator

E – the epoxy primer (additional coating increases the corrosion resistance of the product).