

Angus DW



 colour included
in the price



ARTES
DESIGN

Angus DW 1450↑ × 520⇔ ZX
colour: Chrome Effect

Inline integrated thermostatic valve set, right, chrome
Integrated pipe-masking set, chrome



TERMA
SINCE 1990

Angus DW



colour included
in the price

Design: Artes Design

Standard connection:

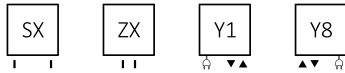

Optional connection:

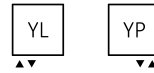

Electric radiators:

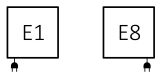

Available sizes:

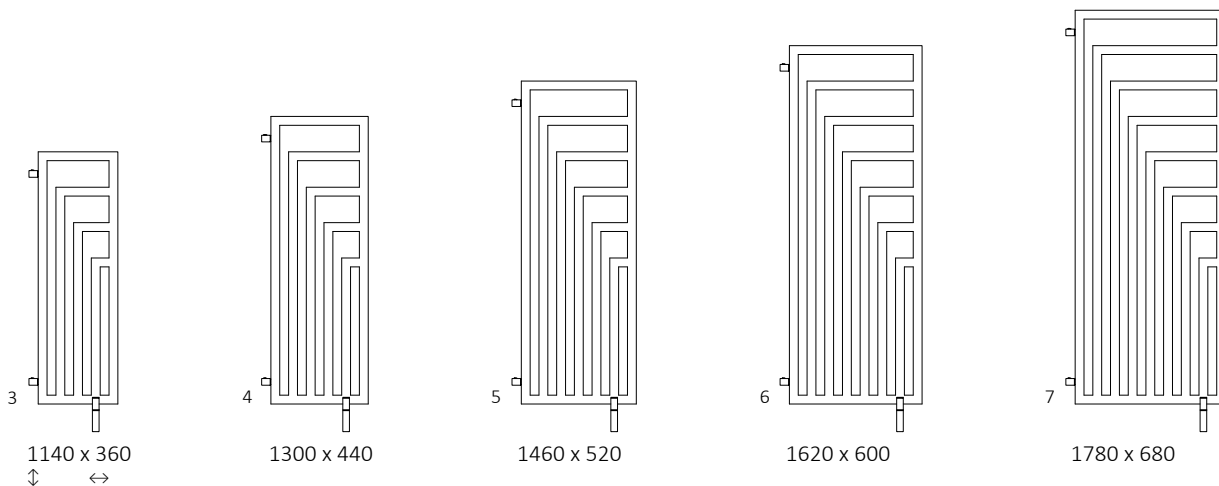

Specification:

Working pressure: 800 kPa Maximum operating temperature: 95°C

A ↓ [mm]	B ↔ [mm]	C1 [mm]	C2 [mm]	75/65/20°C [W]	55/45/20°C [W]	⊙ [W]	E [mm]	F [mm]	U [dm³]	⚖️ [kg]	Product code <small>Configuration code p. 5</small>
1140	360	50	320	421	224	400	940	100	5,18	11,50	WGANS114036
1300	440	50	400	557	293	600	1100	100	6,92	15,36	WGANS130044
1460	520	50	480	711	372	800	1260	100	8,88	19,71	WGANS146052
1620	600	50	560	905	472	1000	1420	100	11,07	24,57	WGANS162060
1780	680	50	640	1116	580	1200	1580	100	13,48	29,92	WGANS178068



colour included
in the price

Technical drawing:

ZX

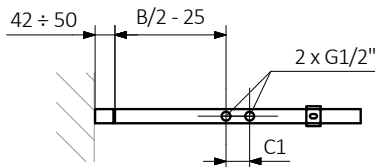

SX

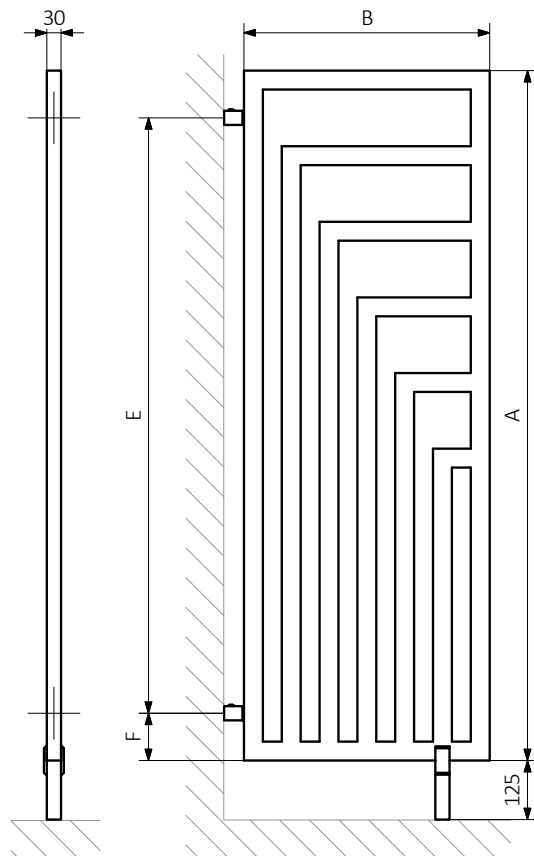
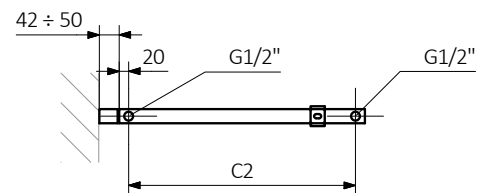

Y1

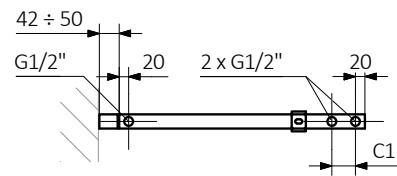

Y8

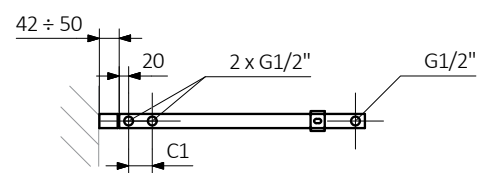

A – Height B – Width C1-C5 – Distance between pipe centres D – Horizontal distance between mounting bracket centres
E – Vertical distance between mounting brackets F – Distance between a mounting bracket and the bottom of the radiator

Pipe:

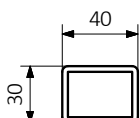



colour included
in the price

In the table with technical data, the last column lists product codes. When placing an order, please remember to quote the product code followed by the configuration code as shown in the diagram below:

The construction of a water and dual fuel radiator product and configuration code

WGANS114036

K916ZX

PRODUCT CODE
(located in the table for the product)

CONFIGURATION CODE
(supplemented by hand)

Example Configuration

K 916 ZX

Package code Colour code Connection code
K - carton box

Construction of electric heater configuration code:

WLANS114036

K916E1DRYM

PRODUCT CODE
(located in the table for the product)

CONFIGURATION CODE
(supplemented by hand)

Example Configuration

K 916 E1 DRY M

Package code Colour code Connection code Heating element code Type of heating element cable code
K - carton box

Epoxy primer

E – Code of epoxy primer is an extra processes.

WGANS114036 K916ZX **E** — *Extraprocesses or additions code*

Angus DW



 colour included
in the price

Legend



Radiator available in a "water" version.



Radiator suitable for dual fuel connection. Electric heating element can be installed.



Radiator available in electric only version. It comes prefilled with a 'heating medium' and equipped with a heating element. All tested and ready to use.



Connection types dedicated for this radiator. The icon shows the flow and return connections for the radiator as well as the thermostatic valve and heating element position if applicable.



Suggested heating element power output for electric and dual fuel versions.



Weight.



Capacity.



Available in chrome finish.



No additional payment for a color.