



Hudevad P5V



Technical datasheet

HUDEVAD
RADIATOR DESIGN

Stelrad Radiator Group

Key benefits



Tradeamark Hudevad design

Minimalistic, Scandinavian style



Vertical design

Ideal for installation in rooms with limited wall space



Fully welded solution

No removable parts making it highly durable and completely tamper-proof



Available with towel rails or pegs

Making it ideal for bathrooms and kitchens

Index

Description.....	4
Illustrations	5
Dimensions.....	6
Height and length	6
Depth	6
Build-in dimensions	7
Position of straps	8
Tapping dimensions	9
Built-in valves.....	10
Placement of outlets/PEX boxes	12
UR Flex.....	13
Output	14
Options.....	15
Towel pegs.....	15
Towel rails.....	17
Accessories	19
Tappings	19
Tapping variations	20

Description

The Hudevad P5V has a discreet appearance to emphasise your room's unique architecture. Featuring the classic Hudevad design with a rebated water-filled front panel, closed ends and discreet bottom tappings, the Hudevad P5V is an elegant and minimalistic vertical heat source. Combined with an excellent heat output, it provides unmatched performance and design characteristics.

Material	Front plate: 2.00 mm steel to EN 10051 Rear plate: 1.25 mm steel to EN 10130 P5KV convector fins: 0.50 mm steel to DIN 239
Test pressure	10 bar
Max. operating pressure	7.7 bar in accordance with EN 442
Max. operating temperature	95°C
Surface treatment	Pretreatment: Degreasing and passivation Priming: Primed with water based paint in pale grey Surface treatment in accordance with DIN 55900 and EN 442
Length	P5V/P5KV and P5VD/P5KVD: 300, 400, 500, 600, 700 og 1000 mm Type 43C/108C (P5V/P5VD) is only applicable for length 1000 mm - see p. 3
Height	P5V/P5KV and P5VD/P5KVD: 800-4000 mm, increments of 100 mm Optional increments of 33.33 mm
Depth	P5V: 40 mm, P5V 43C: 43 mm, P5KV: 58 mm P5VD: 105 mm, P5VD 108C: 108 mm, P5KVD: 123 mm
Tappings	1/2" standard, adapter for 3/4"
Installation	Wall or floor mounted Brackets are included Air vents and plugs are included
Optional extras	Towel rails / Towel pegs Adjustable brackets
Colour	Powder-coated white RAL 9010, gloss 70 Option: Painted in other standard RAL and BS colours

Illustrations

Cutaway

P5V single

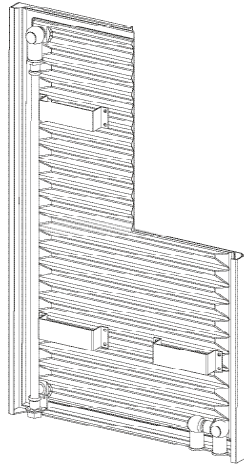

P5V single without convectors (P5V)

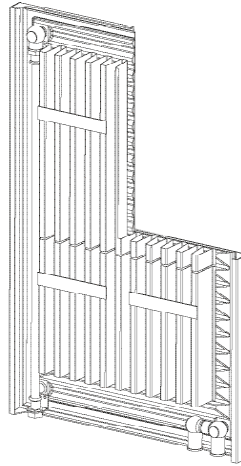

P5V single with convector (P5KV)

P5V double

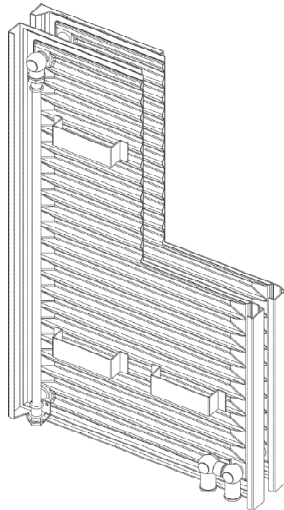

P5V double without convectors (P5VD)

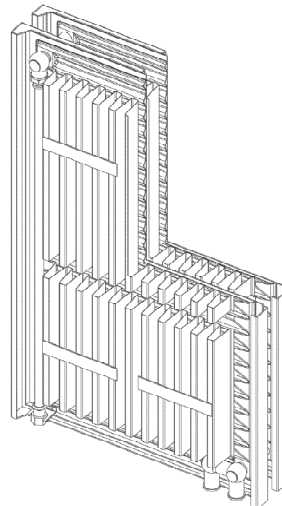

P5V double with convectors (P5KVD)

Dimensions

Height and length

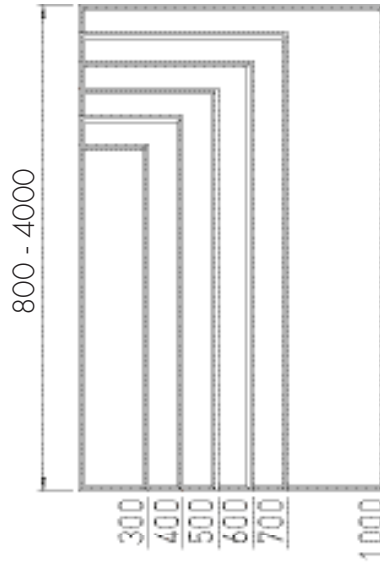

Depth

P5V



P5V 43C
L:1000 mm

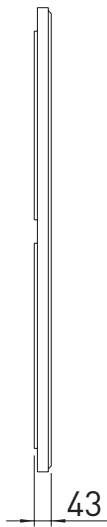

P5KV

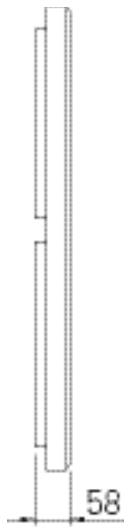

P5VD



P5VD 108C
L:1000 mm

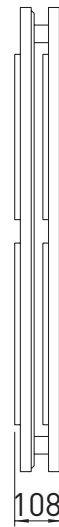

P5KVD

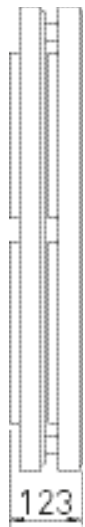

Build-in dimensions

Profile view

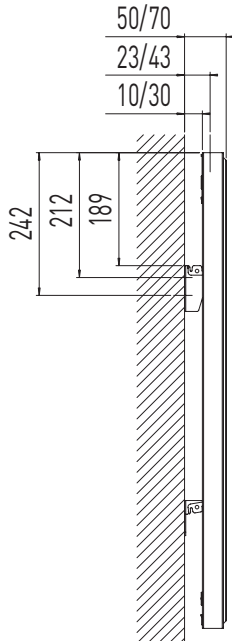

P5V

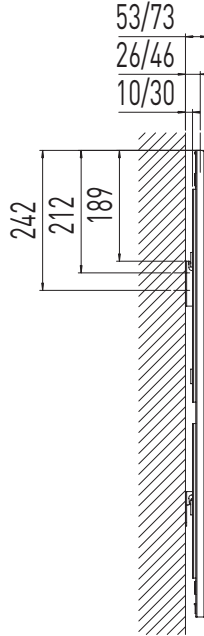

P5V 43C,
L: 1000 mm

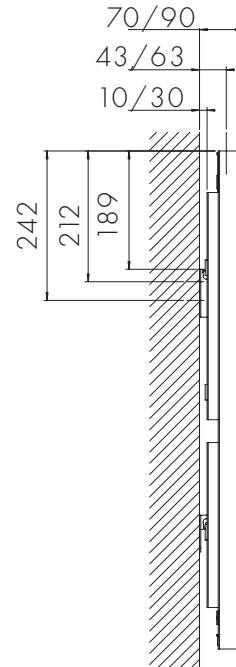

P5KV

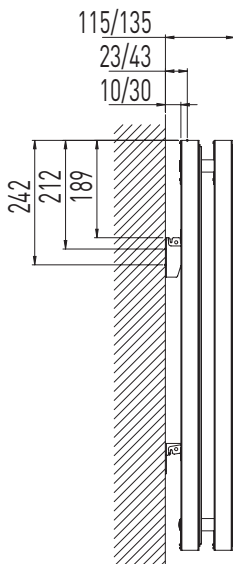

P5VD

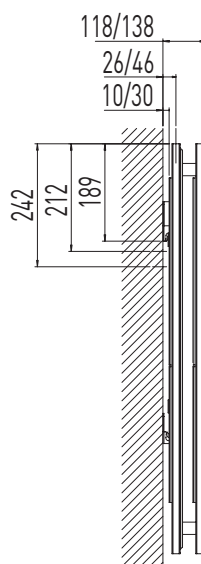

P5VD 108C,
L: 1000 mm

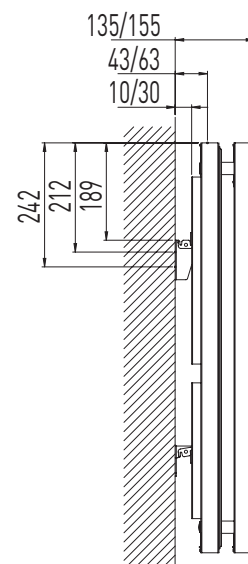

P5KVD

Position of straps

Rear view

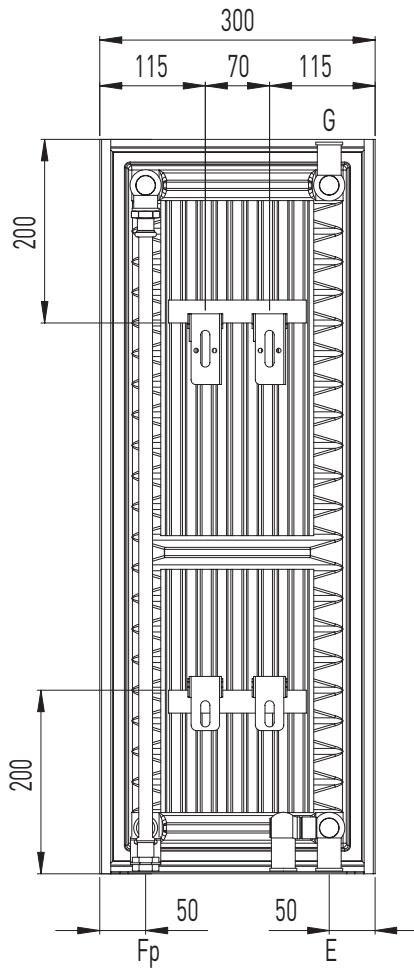

P5V/P5KV, 300 mm

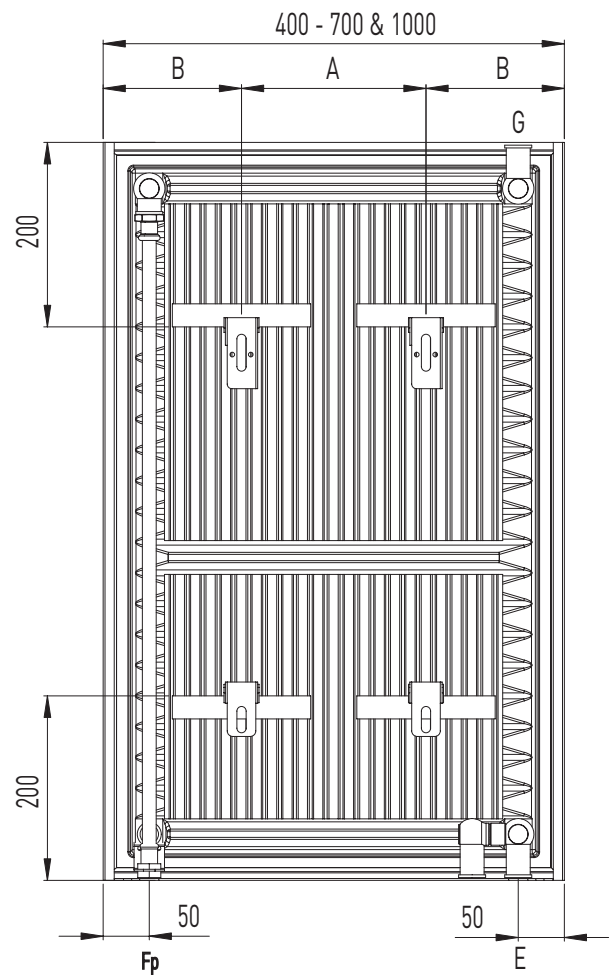

P5V/P5KV, 400 - 700 and 1000 mm

P5V/P5KV position of brackets/rails

Radiator length L, mm	A, mm	B, mm
400	100	150
500	200	150
600	300	150
700	400	150
1000	700	150

P5V/P5KV no. of brackets / spacers / rails

Radiator length L, mm	Radiator height, mm	Number of brackets / spacers / mounting rails
300	800-2500	2/2/2
400-700 and 1000	800-2500	2/2/4

Tapping dimensions

Top and bottom tapings

P5V and P5KV, lengths 300-700 and 1000 mm

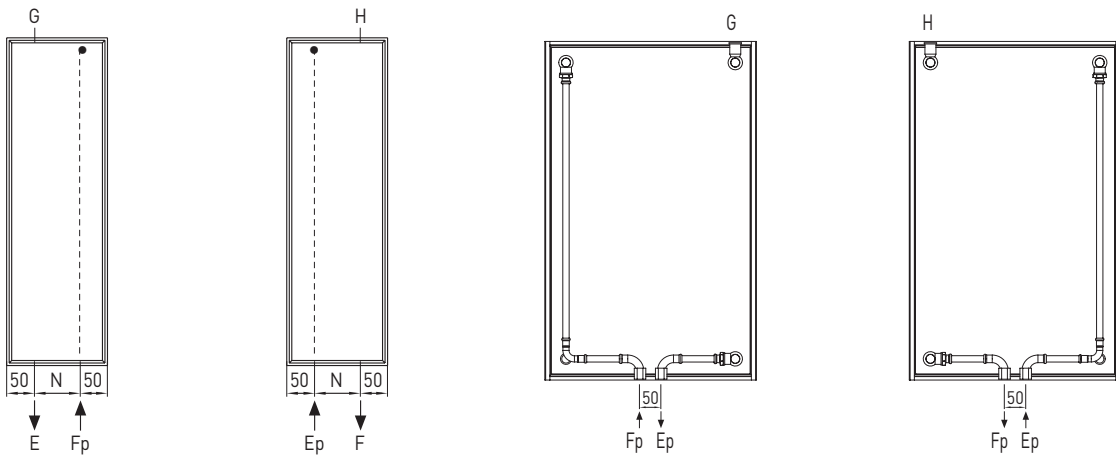

Centerdistance N is calculated as: Radiator length L-100 mm

Profile view

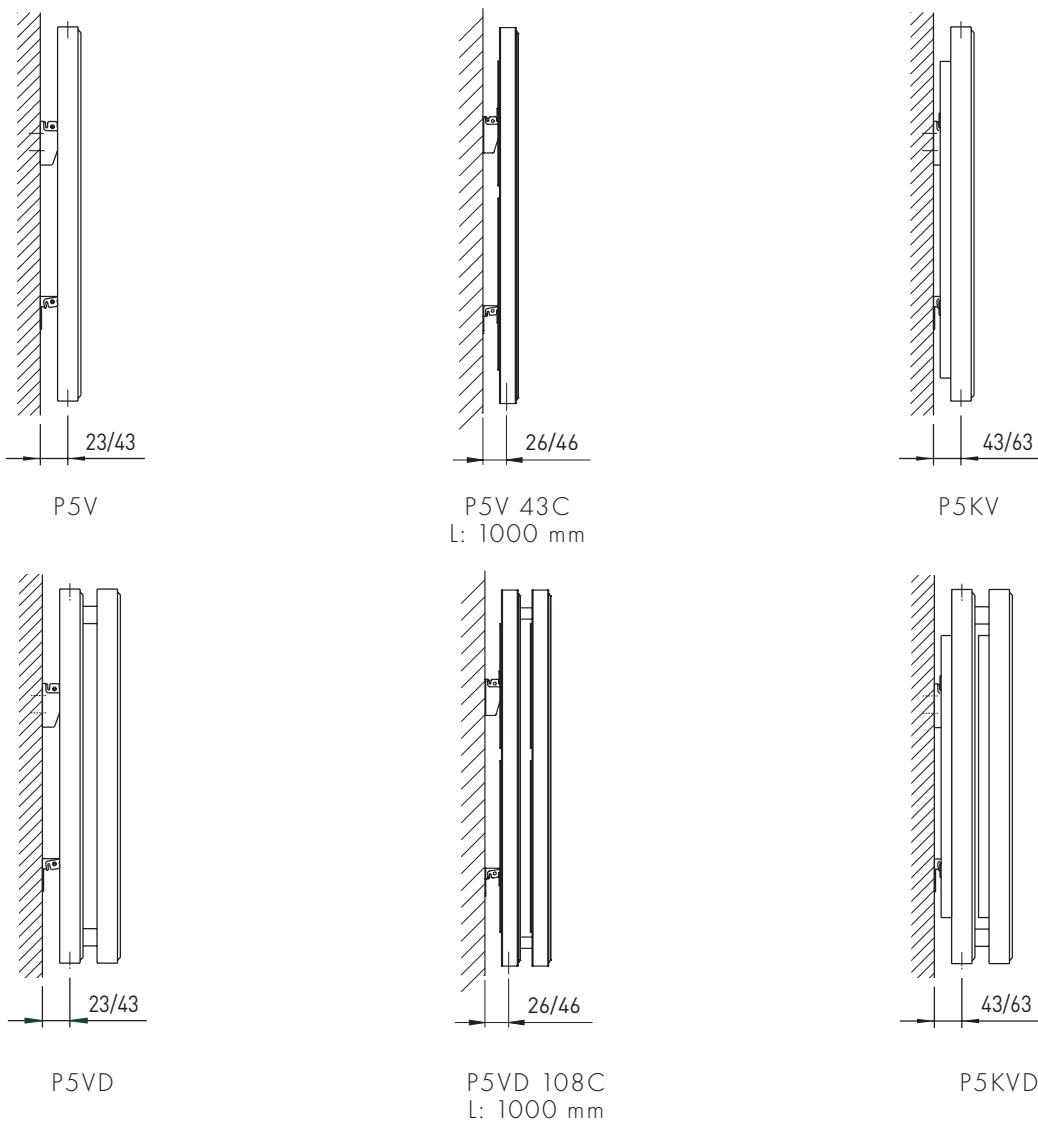

HUDEVAD
RADIATOR DESIGN

Stelrad Radiator Group

Built-in valve systems

Top and bottom tappings

- Application** For use where a thermostatic valve is to be integrated within the radiator, where discreet pipework is required or for the ease of installation. The valve sensor and thermostatic head is placed through a hole in the front plate (type 1).
- Tappings** Radiator with type 1 valve has downwards facing 1/2" tappings. It is possible to order tapping combinations EE/FF and EF/FE as well as air vent opposite valve. UR-flex, hidden piping for all depths can be used.
- Dimensions** Min. length with built-in valve is 15 sections.
Performance-wise the built-in valve occupies 2 sections.
- Built-in valve** With type 1 valve is delivered with spindle extensions for type P5VD and P5KVD.
Note: Spindle extensions are demounted for presetting.
- Note** Due to the placement of the valve, radiators with built-in valve type 1 have a 100 mm shorter water-filled panel. On type P5KV there are fewer convactor ribbons in order to provide space for the built-in valve. The result is a reduced output of approximately 30-50 Watt depending on the radiator width.

Built-in valve type 1

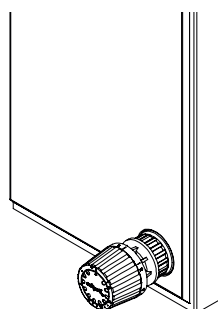

P5V (all variations) with built-in valve type 1 (front)

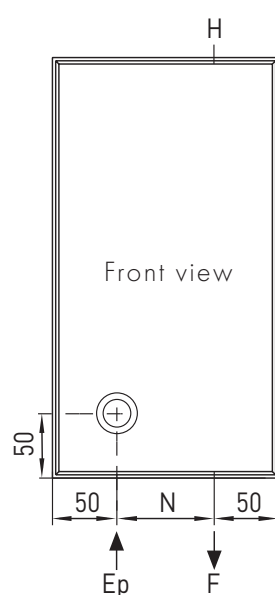

Lengths 300-700
and 1000 mm,
with built-in
valve type 1

Profile view

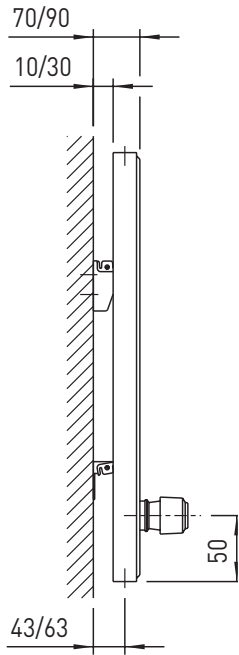

P5V

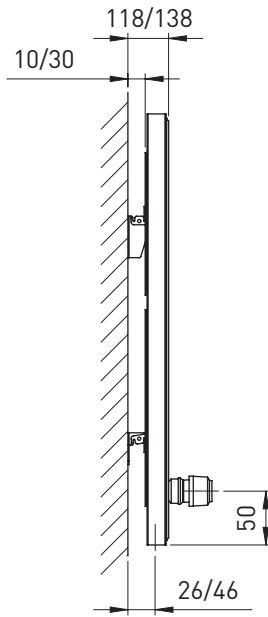

P5V 43C, L: 1000 mm

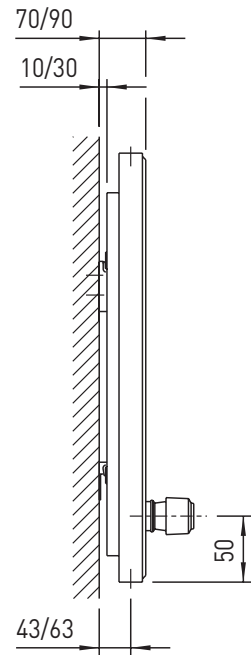

P5KV

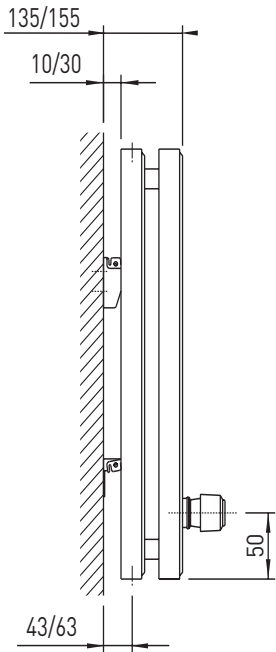

P5VD

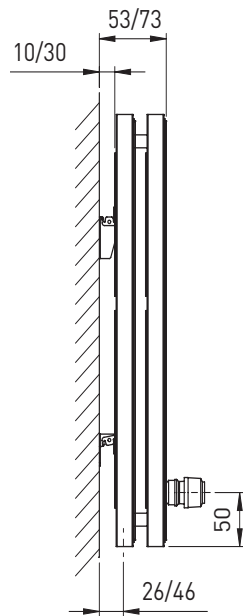

P5VD 108C, L: 1000 mm

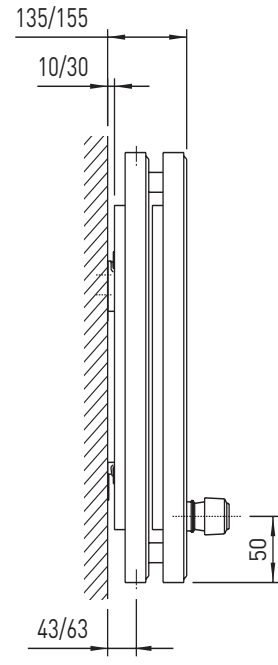

P5KVD

Placement of outlets/PEX boxes

Model designations as well as dimensional drawings for placement of wall outlets/PEX boxes.

Built-in valve type 1

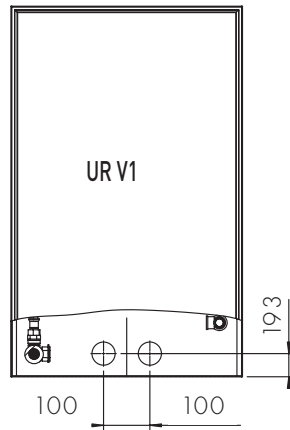

EF/FE tapplings

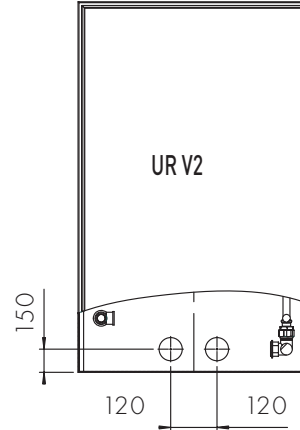

EF/FE tapplings

Without valve

Model designations as well as dimensional drawings for placements of wall outlets//PEX boxes.

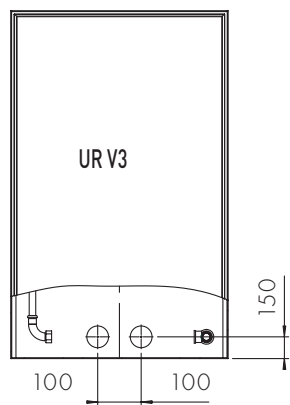

EF/FE tapplings

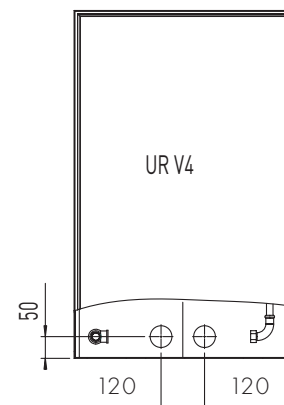

EF/FE tapplings

UR-flex

Descripton

Simple and timeless design that fits with any architecture where you want to hide all connections behind the radiators. Flexhoses made of high density armored medical silicone as a fixed accessory til the radiators. Easily cleaned because of the flat front plate and the hidden connections.

The radiator is produced with tappings and UR-flex tubes placed on the backside, so only the air valve and the built-in valve is visible on the front plate.

Notes

At radiator length 300mm the distance between wall outlet is 50mm

Applicable to

P5V and P5KV (depth 40/43 and 58)
P5V-D and P5KV-D (depth 105/108 and 123)

Wall distance

30 mm (all depths)

Installation

UR-flex tubes (provided by Hudevad) are mounted between the radiators hidden tappings and the plumbing installers wall outlets/PEX cans. Delivered with flexhoses made of high density armored medical silicone. The radiator is mounted using brackets as normal.

UR-flex radiator options are produced without valve as well for central placement of valve in technical room or alike.

Profile view

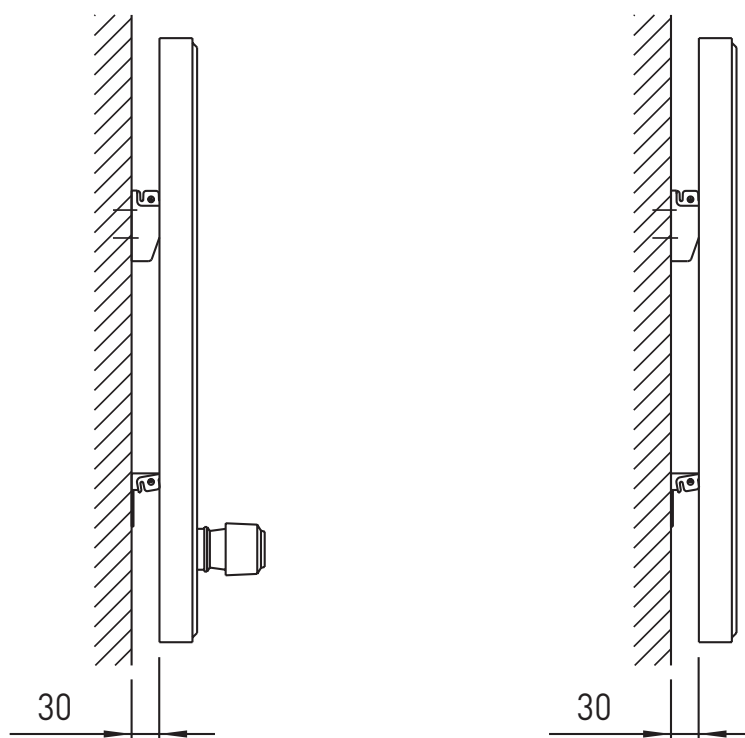

P5V UR-flex, built-in valve type 1

P5V UR-flex, without valve

Output

P5V

Height: 1000 mm		Output			Water content	Weight
Length, mm	W/m 75°/65°/20°	W/m 55°/45°/20°	W/m 70°/40°/20°	liter/m	kg/m	
300	325	172	208	0,8	8,1	
400	434	229	278	1,1	10,8	
500	542	286	347	1,4	13,5	
600	651	344	417	1,6	16,1	
700	759	401	486	1,9	18,8	
1000	1084	573	694	2,7	26,9	

P5KV

Height: 1000 mm		Output			Water content	Weight
Length, mm	W/m 75°/65°/20°	W/m 55°/45°/20°	W/m 70°/40°/20°	liter/m	kg/m	
300	402	212	257	0,8	10,8	
400	536	283	343	1,1	14,4	
500	670	354	429	1,4	18,0	
600	804	424	515	1,6	21,6	
700	937	495	600	1,9	25,2	
1000	1339	707	858	2,7	36,0	

P5VD

Height: 1000 mm		Output			Water content	Weight
Length, mm	W/m 75°/65°/20°	W/m 55°/45°/20°	W/m 70°/40°/20°	liter/m	kg/m	
300	540	284	345	1,6	16,1	
400	720	378	459	2,2	21,5	
500	900	473	574	2,7	26,9	
600	1080	568	689	3,2	32,3	
700	1260	662	804	3,8	37,7	
1000	1800	946	1149	5,4	53,8	

P5KVD

Height: 1000 mm		Output			Water content	Weight
Length, mm	W/m 75°/65°/20°	W/m 55°/45°/20°	W/m 70°/40°/20°	liter/m	kg/m	
300	724	377	459	1,6	21,6	
400	965	502	612	2,2	28,8	
500	1207	628	764	2,7	36,0	
600	1448	753	917	3,2	43,2	
700	1689	879	1070	3,8	50,4	
1000	2413	1255	1529	5,4	72,0	

Options

Towel pegs



Towel radiator with 3 pegs

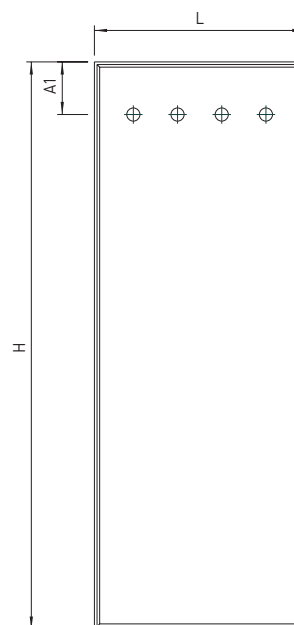

P5V and P5KV with 4 towel pegs



Towel pegs

Cupo, Torus and Striato towel pegs: Solid brass
Vitro towel pegs: Steel (stainless)

Surface treatment of towel pegs:
Cupo, Torus and Striato: Chrome
Vitro: Glass blown, matt

Placement of towel pegs

Radiator height, H, mm	Number of sections	A1, mm
800 - 1600	24 - 48	100
1633 - 2000	49 - 60	H - 1450

Profile view

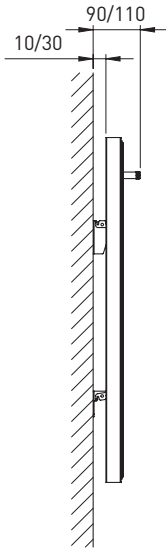

P5V with towel pegs

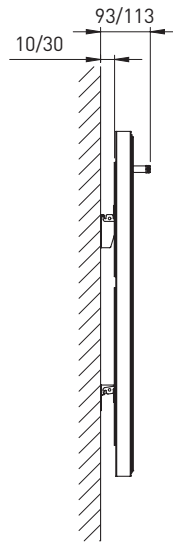

P5V 43C with towel pegs,
L: 1000 mm

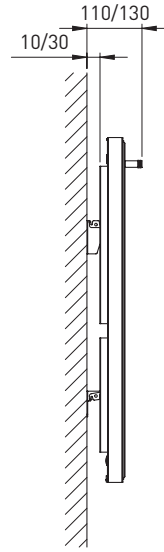

P5KV with towel pegs

Peg styles and dimensions

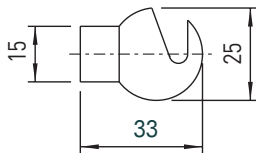

Cupo

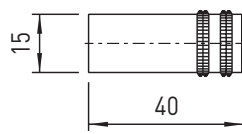

Torus

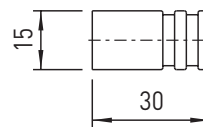

Striato

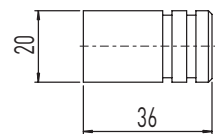

Vitro

Item number for ordering of towel pegs

Towel pegs		Item number			
Surface treatment	Amount	Cupo	Torus	Striato	Vitro
Chrome	1	930450101	930450201	930450301	
Glass blown, matt	1				930450099
Gold	1	930450111	930450211	930450311	

Radiator length, mm	Number of pegs
300	2-3
400	2-4
500	3-4
600	3-5
700	3-5

Note: Depending of the radiator length, you can order 2-5 towel pegs, see the table above.

Towel rails

Front view



P5V with 1 rail

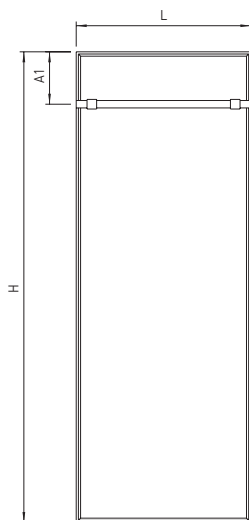

P5V and P5KV with 1 rail

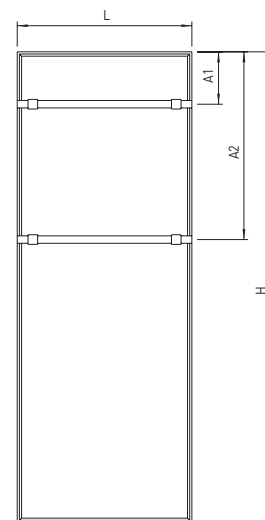

P5V and P5KV with 2 rails

Rail types

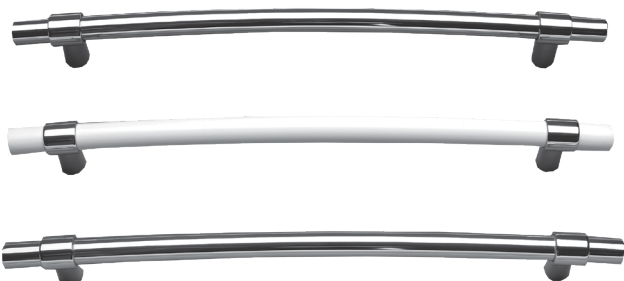

Material:
Solid brass $\varnothing 17$ mm with supports in brass.

Rails are comprised of the two supports and a rod.
The surface treatment options are as follows:

- Rod: Gold · Support: Gold
- Rod: Chrome · Support: Chrome
- Rod: White · Support: Gold
- Rod: White · Support: Chrome

Placement of towel rails

Radiator height, H, mm	Number of sections	A1, mm	A2, mm
800 - 1167	24 - 35	H x 0,1	-
1200 - 1800	36 - 54	H x 0,1	H x 0,4
1833 - 2000	55 - 60	H - 1620	H - 1180

Profile view

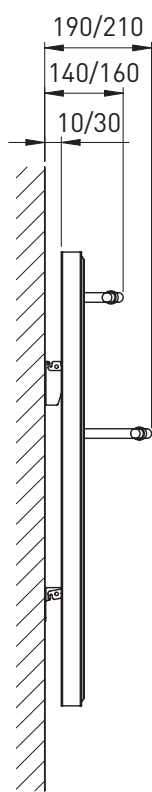

P5V with 2 towel rails

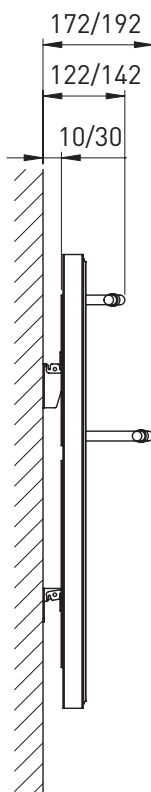

P5V 43C with 2 towel rails,
L: 1000 mm

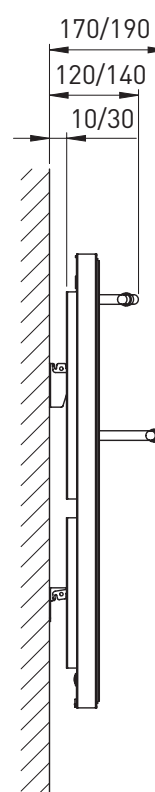

P5KV with 2 towel rails

Note: Towel rails available in lengths 400, 500 og 600 mm and depths 70 and 120 mm. Towel rails can be place individually as desired.

Dimensions Length x depth, mm	Rod / Support			
	Gold / Gold	Chrome / Chrome	White / Gold	White / Chrome
600 x 70	930450601	930450600	930450603	930450602
500 x 70	930450501	930450500	930450503	930450502
400 x 70	930450401	930450400	930450403	930450402
600 x 120	930450605	930450604	930450607	930450606
500 x 120	930450505	930450504	930450507	930450506
400 x 120	930450405	930450404	930450407	930450406

When ordering towel rails, fixed item numbers can be used, see table below.

Accessories

*Bracket BP10/30

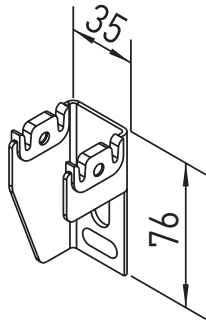

Spacer

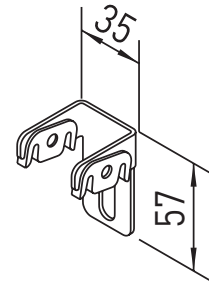
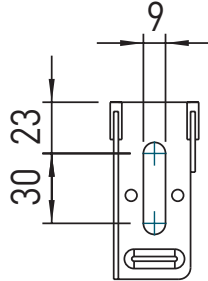

Adjustable brackets

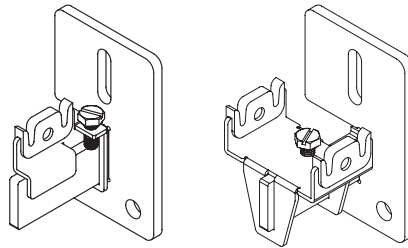

*Optional wall distance: 10 or 30 mm to the rear of the radiator
UR-flex: Wall distance 30 mm

Tappings

Standard tappings: 1/2" EEFpG / *EpFFH

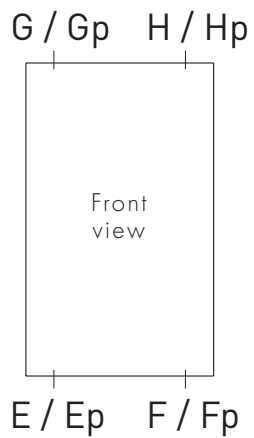

Tappings variations

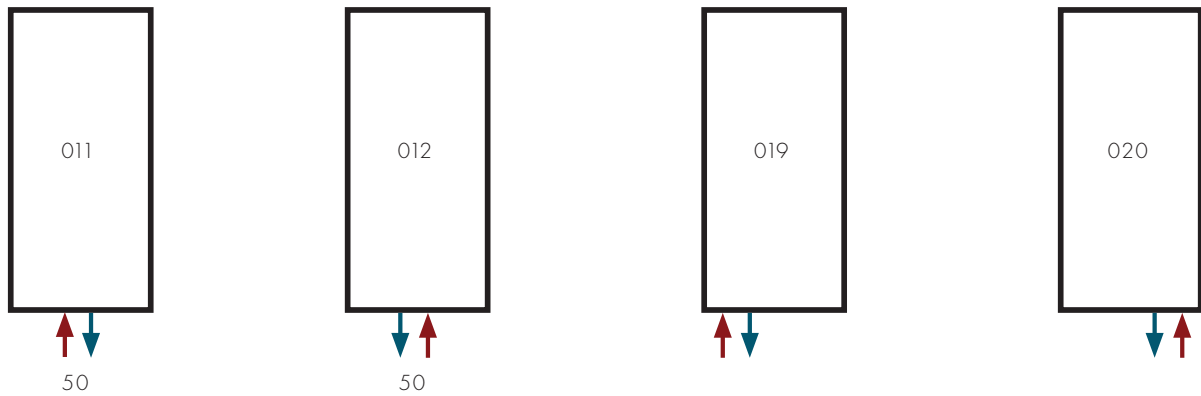
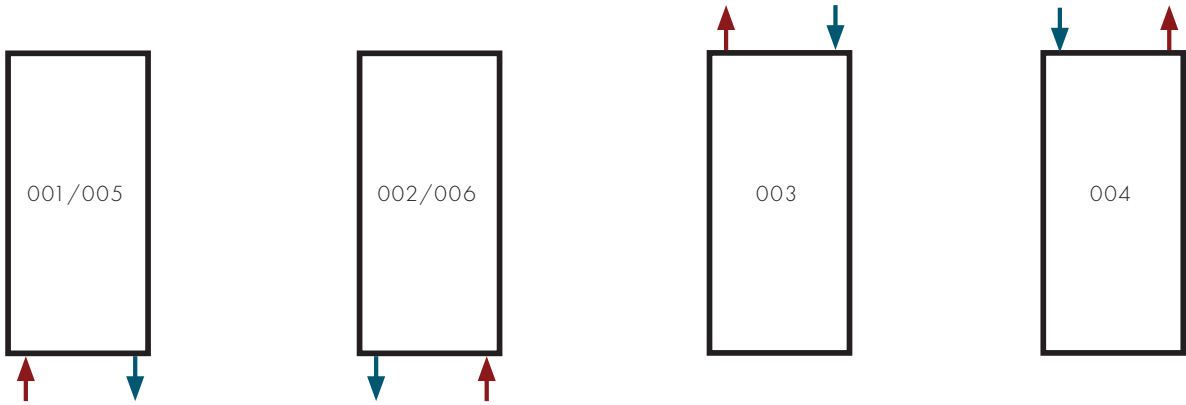

Built-in valve type 1

Built-in valve type 1

Built-in valve type 1

Built-in valve type 1

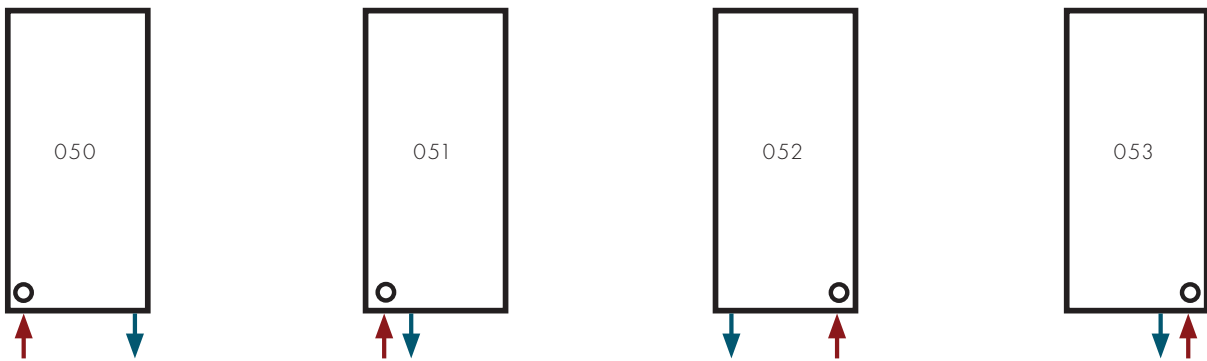

Built-in valve type 1

Built-in valve type 1

