

Delfin

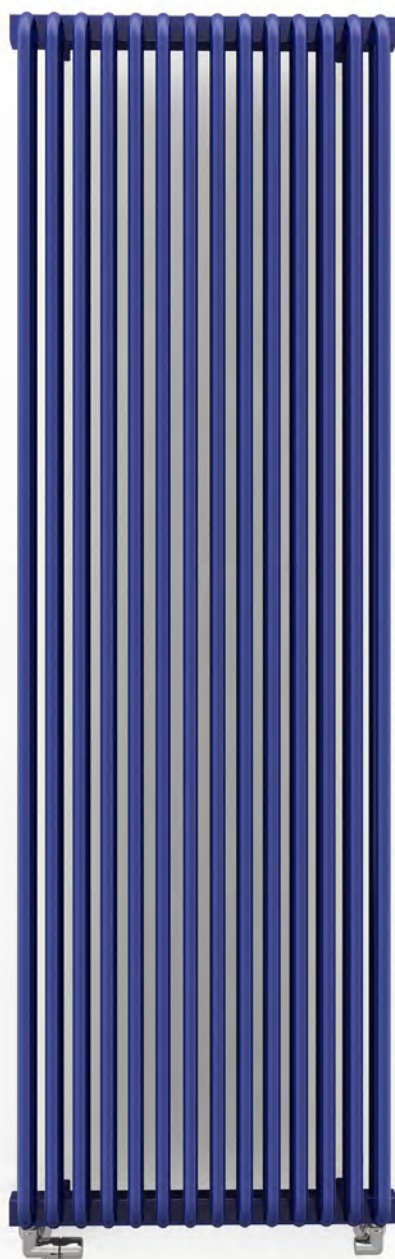

 colour included
in the price



Delfin 1800 \downarrow × 580 \leftrightarrow SX
colour: RAL 5022

3-axis thermostatic valve set, left, chrome
Pipe-masking set, chrome



TERMA
SINCE 1990





colour included
in the price

Projekt : *Terma*

Standard connection:

A ↑ 440÷2000:

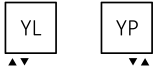

A ↑ 440÷640:

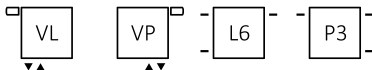

A ↑ 1800÷2000:

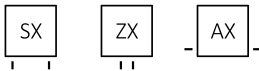

Electric radiators:

A ↑ 440÷640:

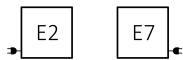

Optional connection:

A ↑ 440÷2000:



A ↑ 440÷640:

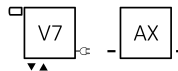
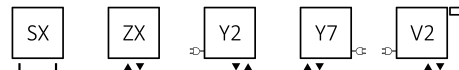

A ↑ 1800÷2000:

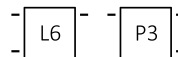

Specification:

Working pressure: 800 kPa Maximum operating temperature: 95°C

A ↓ [mm]	B ↔ [mm]	C1 [mm]	C2 [mm]	C3 [mm]	C4 [mm]	75/65/20°C [W]	55/45/20°C [W]	⊙ [W]	D [mm]	E [mm]	F [mm]	H [dm³]	⚖️ [kg]	Product code <small>Configuration code p. 8</small>
440	820	50	780	400	820	705	370	800	710	400	20	6,41	14,30	WGDLF044082
440	1020	50	980	400	1020	885	465	800	910	400	20	8,01	17,82	WGDLF044102
440	1220	50	1180	400	1220	1061	556	1000	1110	400	20	9,60	21,34	WGDLF044122
540	820	50	780	500	820	846	442	800	710	500	20	7,61	16,97	WGDLF054082
540	1020	50	980	500	1020	1057	553	1000	910	500	20	9,50	21,16	WGDLF054102
540	1220	50	1180	500	1220	1264	661	1200	1110	500	20	11,39	25,35	WGDLF054122
640	820	50	780	600	820	986	514	1000	710	600	20	8,80	19,65	WGDLF064082
640	1020	50	980	600	1020	1233	644	1200	910	600	20	10,99	24,50	WGDLF064102
640	1220	50	1180	600	1220	1458	760	1500	1110	600	20	13,19	29,36	WGDLF064122
1800	500	50	460	1760	500	1403	717	-	390	1760	20	13,61	30,48	WGDLF180050
1800	580	50	540	1760	580	1623	830	-	470	1760	20	15,87	35,52	WGDLF180058
2000	500	50	460	1960	500	1556	802	-	390	1960	20	15,04	33,68	WGDLF200050
2000	580	50	540	1960	580	1774	909	-	470	1960	20	17,55	39,26	WGDLF200058



 colour included
in the price

Available sizes:

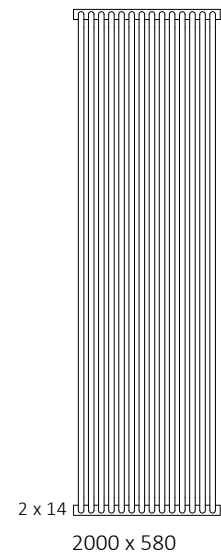
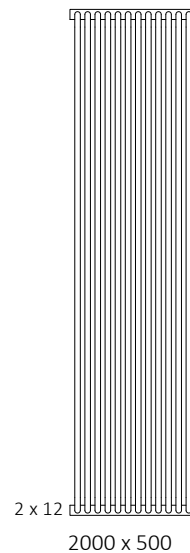
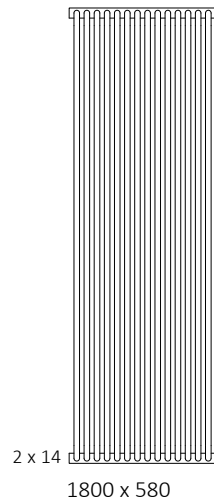
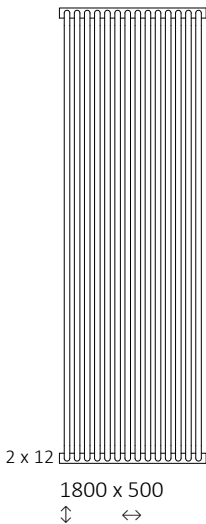
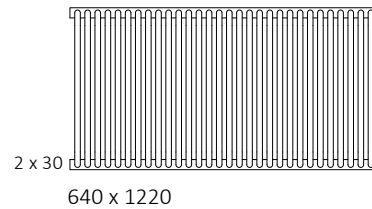
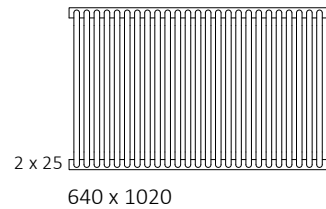
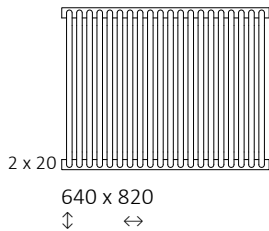
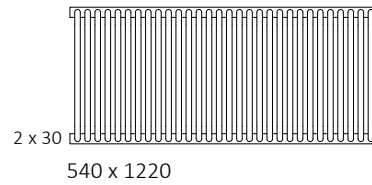
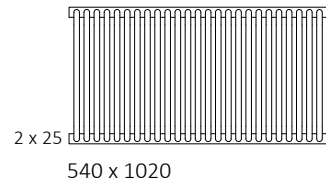
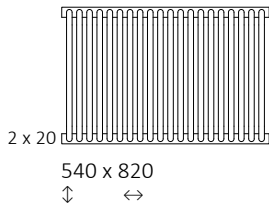
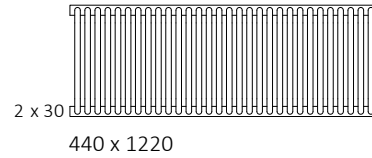
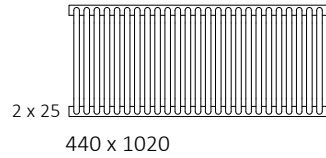
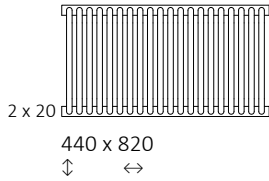



colour included
in the price

Technical drawing:

L6

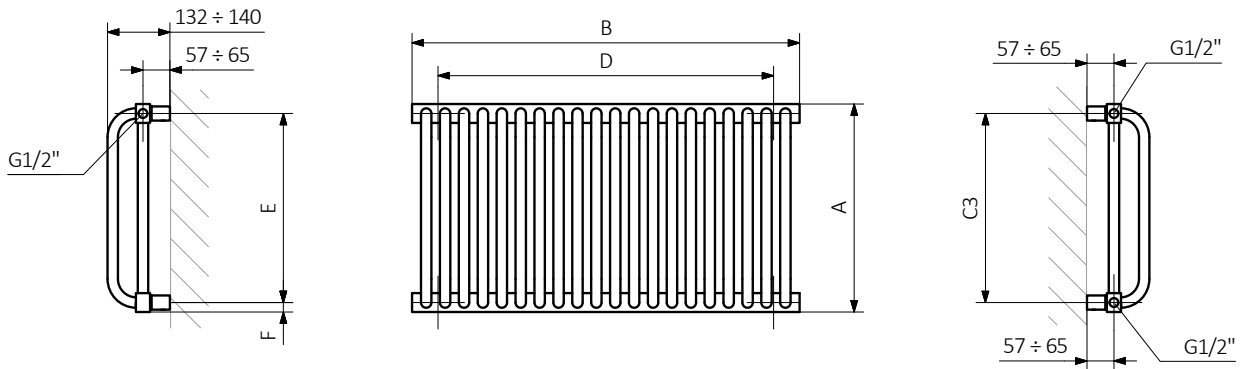

P3

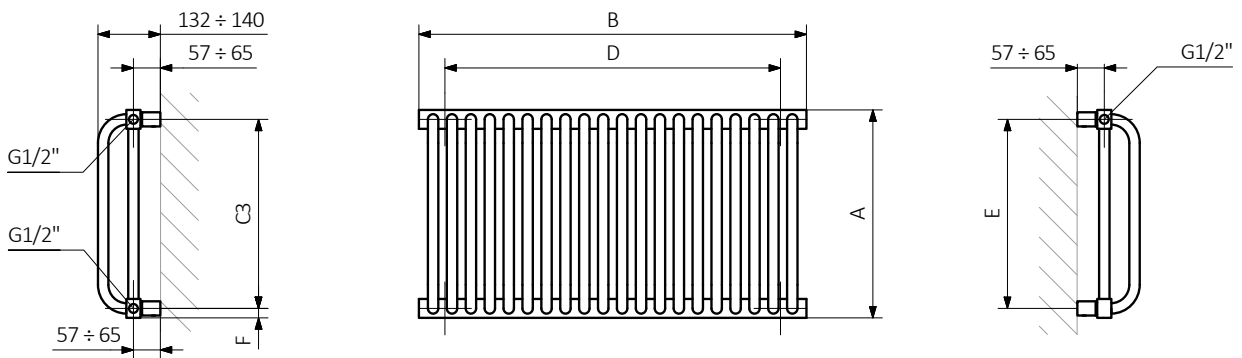

YL

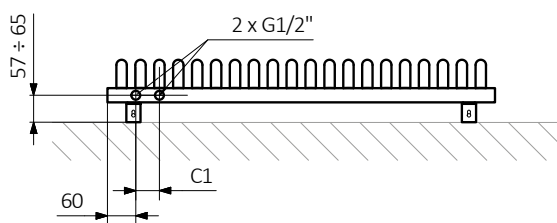

YP

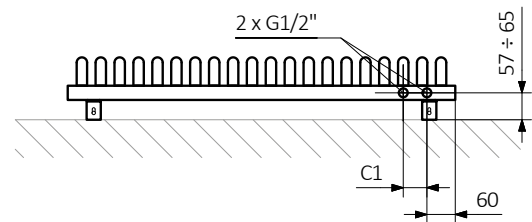

A – Height B – Width C1-C5 – Distance between pipe centres D – Horizontal distance between mounting bracket centres
E – Vertical distance between mounting brackets F – Distance between a mounting bracket and the bottom of the radiator

Collector :

Pipe :

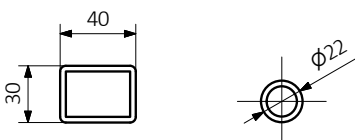



colour included
in the price

Technical drawing:

VL

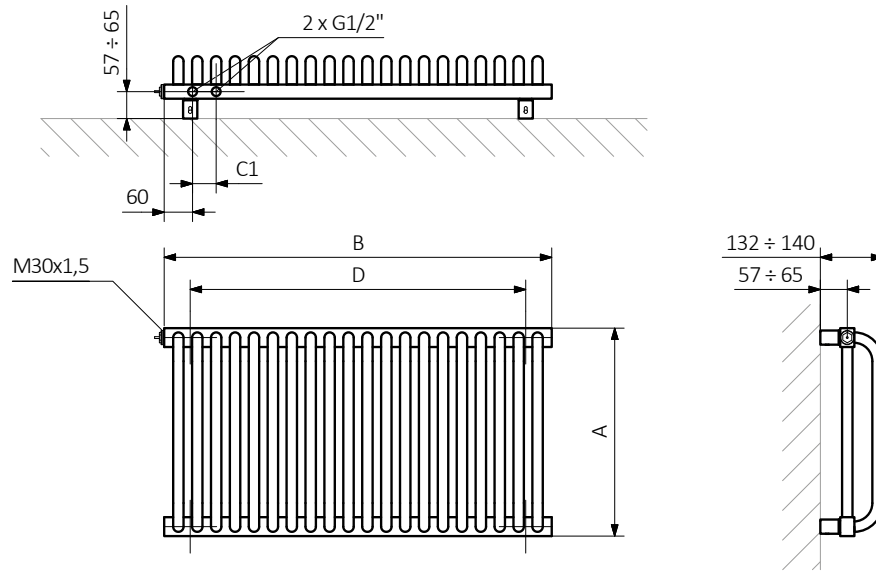

VP

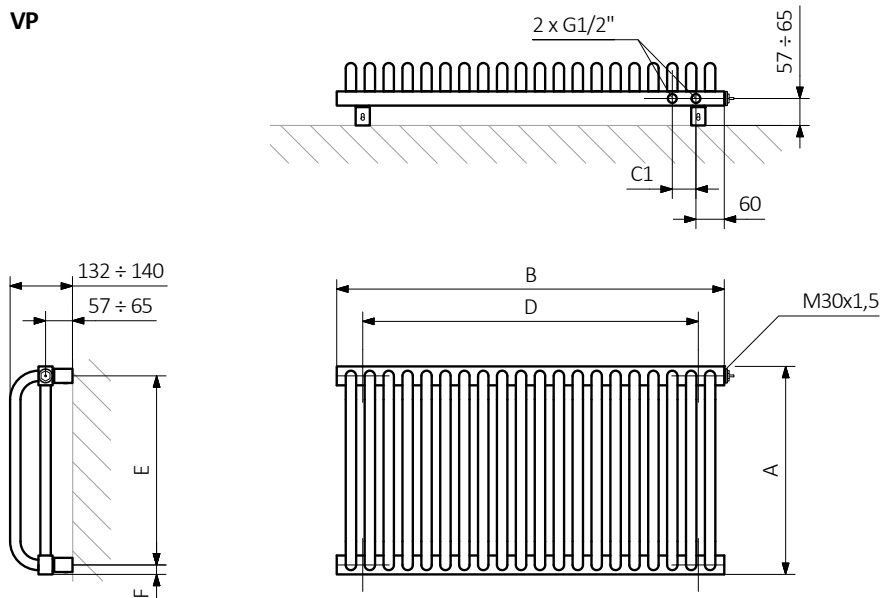

A – Height B – Width C1-C5 – Distance between pipe centres D – Horizontal distance between mounting bracket centres
E – Vertical distance between mounting brackets F – Distance between a mounting bracket and the bottom of the radiator

Collector :

Pipe :

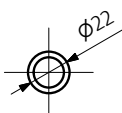
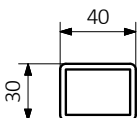



colour included
in the price

Technical drawing:

AX

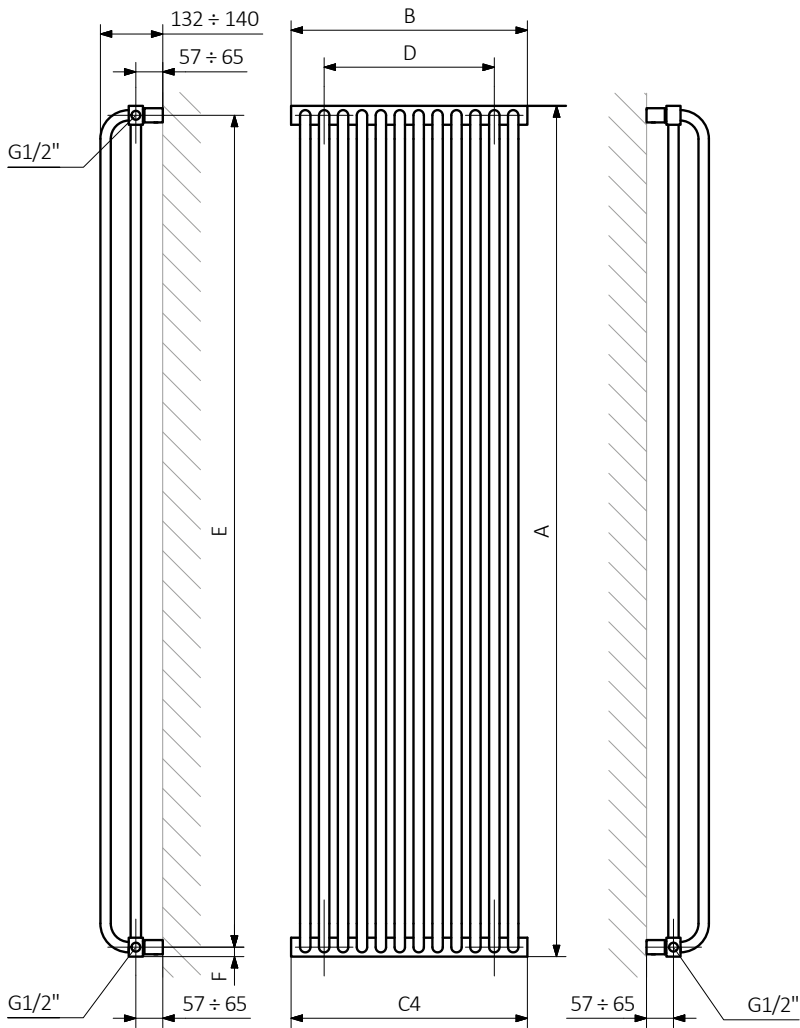

SX

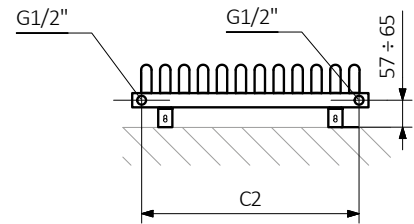

ZX

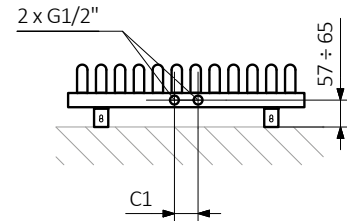

YP

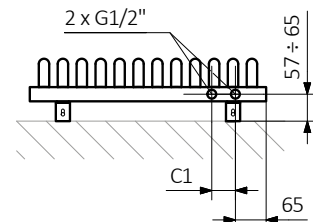

YL

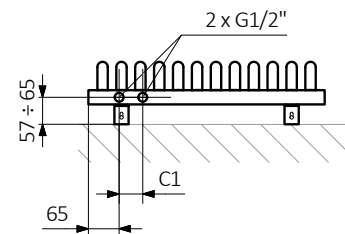

A – Height B – Width C1-C5 – Distance between pipe centres D – Horizontal distance between mounting bracket centres
E – Vertical distance between mounting brackets F – Distance between a mounting bracket and the bottom of the radiator

Collector:

Pipe:

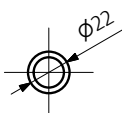
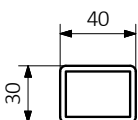



 colour included
in the price

In the table with technical data, the last column lists product codes. When placing an order, please remember to quote the product code followed by the configuration code as shown in the diagram below:

The construction of a water and dual fuel radiator product and configuration code:

WGDLF044082

K916SX

PRODUCT CODE
(located in the table for the product)

CONFIGURATION CODE
(supplemented by hand)

Example Configuration

K 916 SX

Package code

Colour code

Connection code

K - carton box

Construction of electric heater configuration code:

WLDLF044082

K916E2DRYW

PRODUCT CODE
(located in the table for the product)

CONFIGURATION CODE
(supplemented by hand)

Example Configuration

K 916 E2 DRY W

Package code

Colour code

Connection code

Heating element code

Type of heating element cable code

K - carton box

Epoxy primer

E – Code of epoxy primer is an extra processes.

WGDLF044082 K916SX **E** — *Extrapolicesoradditionscode*



colour included
in the price

Legend



Radiator available in a "water" version.



Radiator suitable for dual fuel connection. Electric heating element can be installed.



Radiator available in electric only version. It comes prefilled with a 'heating medium' and equipped with a heating element. All tested and ready to use.



Connection types dedicated for this radiator. The icon shows the flow and return connections for the radiator as well as the thermostatic valve and heating element position if applicable.



Suggested heating element power output for electric and dual fuel versions.



Weight.



Capacity.



Available in chrome finish.



No additional payment for a color.